



Cat. No. 43-972

OWNER'S MANUAL

Please read before using this equipment.

System 2000



100 Number Memory
2-Line Caller ID

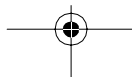

RadioShack™



Warning: To prevent fire or shock hazard, do not expose this product to rain or moisture.

	CAUTION RISK OF ELECTRIC SHOCK. DO NOT OPEN.	
CAUTION: TO REDUCE THE RISK OF ELECTRIC SHOCK, DO NOT REMOVE COVER OR BACK. NO USER-SERVICE-ABLE PARTS INSIDE. REFER SERVICING TO QUALIFIED PERSONNEL.		



This symbol is intended to alert you to the presence of uninsulated dangerous voltage within the product's enclosure that might be of sufficient magnitude to constitute a risk of electric shock. Do not open the product's case.



This symbol is intended to inform you that important operating and maintenance instructions are included in the literature accompanying this product.

© 1996 Tandy Corporation.
All Rights Reserved.
RadioShack is a trademark used by Tandy Corporation.

FEATURES

Your RadioShack Caller ID System 2000 is the latest in telephone Caller ID technology. If Caller ID service is available in your area and you subscribe to it, the telephone company sends the caller's telephone number (and name, if available in your area) and the date and time of the call between the first and second rings. The module displays this information during an incoming call to help you identify the caller and avoid unwanted calls.

You can connect the module to one or two phone lines, and an answering machine if desired. The module's display shows which line received the incoming call.

The module stores and displays up to 100 single (number only) or multiple (name and number) Caller ID records.

Your module includes these features:

Easy Installation — the module easily connects to your telephone line so you can quickly begin using it.

Built-In Error Checking — ensures accurate information.

Line Indicator — shows the phone line on which you received each call.

Call Summary — displays the number of new calls you received.

Large Display — makes it easy to see caller information, phone line information, and the current time and date.

Clock and Date Display — displays the current time and date as provided to Caller ID service subscribers by your local telephone company.

Message Received Indicator — flashes when you get an anonymous call, when you have at least one new call you have not reviewed, or when you have received voice mail (if you have message waiting service).

Trilingual Operation — lets you set the module to display messages in English, French, or Spanish.

Contrast Control — lets you adjust the display contrast for the best readability.

Two Mounting Options — you can place the module on a desk, shelf, or table, or mount it on a wall.

Note: Your module requires one 9-volt battery (not supplied) for backup power.

For your records, we recommend you record the module's serial number here. The number is on the module's bottom panel.

Serial Number: _____

4



This module has been tested and found to comply with all applicable UL and FCC standards.

Important Information:

- To use this module, you must be in an area where Caller ID service is available, and you must subscribe to the service.
- Your module displays the caller's name only if this feature is available in your area.
- The message received indicator flashes when you have voice mail only if this feature is available in your area and you subscribe to it.

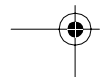
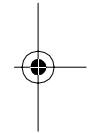

FCC INFORMATION

We have designed your module to conform to federal regulations, and you can connect it to most telephone lines. However, each module (and each device, such as a telephone or answering machine) that you connect to the telephone line draws power from the line. We refer to this power draw as the module's ringer equivalence number or REN. The REN is shown on the bottom of the module.

If you use more than one telephone or other device on the line, add up all of the RENs. If the total is more than five, your telephone might not ring. In rural areas, a total REN of three might impair ringer operation. If ringer operation is impaired, remove a device from the line.

Your module complies with Part 68 of *FCC Rules*. You must, upon request, provide the Federal Communications Commission (FCC) registration number and the REN to your telephone company. Both numbers are shown on the bottom of the module.

Note: You must not connect your module to:

- Coin-operated systems
- Party-line systems
- Most electronic key telephone systems

In the unlikely event that your module causes problems on the phone line, the phone company can temporarily disconnect your service. If this happens, the phone company attempts to notify you in advance. If advance notice is not practical, the phone company notifies you as soon as possible and advises you of your right to file a complaint with the FCC.

Also, the phone company can make changes to its lines, equipment, operations, or procedures that could affect the operation of this module. The phone company notifies you of these changes in advance, so you can take the necessary steps to prevent interruption of your telephone service.

This module complies with the limits for a Class B device as specified in Part 15 of *FCC Rules*. These limits provide reasonable protection against radio and TV interference in a residential area. However, your module might cause TV or radio interference even when it is operating properly.

To eliminate interference, you can try one or more of the following:

- Reorient or relocate the radio or TV receiving antenna
- Increase the distance between the module and the radio or TV
- Use outlets on different electrical circuits for the module and the radio or TV



Consult your local RadioShack store if the problem continues.

If your module is not performing as it should, check its connection to your phones and the phone lines. If you are unable to locate the problem, take your module to your local RadioShack store for assistance.

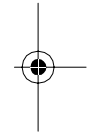
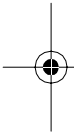

CONTENTS

Preparation.....	11
Connecting the Supplied AC Adapter.....	11
Installing/Replacing the Battery.....	12
Setting the Display Language.....	16
Adjusting the Display Contrast.....	17
Connecting to the Phones/Phone Lines.....	18
Two-Line Phone/Two-Line Phone Line Jack.....	19
Two-Line Phone/Two One-Line Jacks.....	19
One-Line Phone/Two-Line Phone Line Jack.....	20
Two One-Line Phones/Two-Line Phone Line Jack.....	20
Two One-Line Phones/Two One-Line Jacks.....	21
Connecting to an Answering Machine.....	21
Connecting for Both Lines or Line 1 Only.....	22
Connecting for Line 2 Only.....	22
Mounting the Module.....	23
Operation.....	25
Receiving and Storing Calls.....	25
Reviewing Calls.....	26
Displayed Call Information.....	28
Deleting Calls.....	31
Deleting a Single Call.....	31
Deleting All Calls.....	32

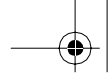

Care and Maintenance.....	33
Lightning.....	34

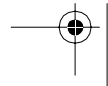
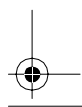
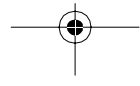
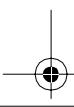
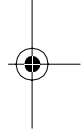

PREPARATION

CONNECTING THE SUPPLIED AC ADAPTER

The supplied AC adapter provides power for the module. Please note that although the module displays a time and date when you connect power, the displayed time and date are incorrect until the phone company sends the correct time and date during the first call.

Cautions:

- Use only the supplied AC adapter. Even other adapters that have the same ratings as the recommended adapter might not work properly.
- Always plug the AC adapter into the module's **9VDC** jack before plugging the adapter's plug into an AC outlet, and unplug the adapter's plug from the AC outlet before unplugging the adapter from the module's **9VDC** jack.

Follow these steps to connect the AC adapter.

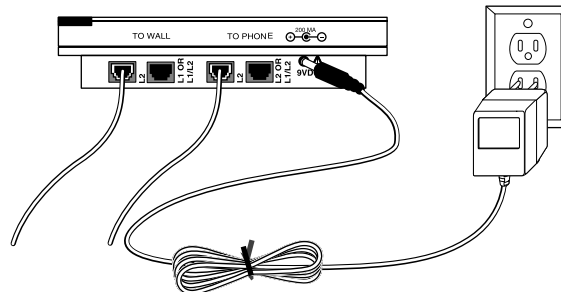

1. Plug the AC adapter's barrel plug into the module's **9VDC** jack.
2. Plug the AC adapter into a standard AC outlet.

INSTALLING/REPLACING THE BATTERY

The module uses a 9-volt battery to protect its memory if the power fails. We recommend you use an alkaline battery (such as RadioShack Cat. No. 23-553).

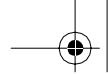

Notes:

- If AC power fails or if the AC adapter is disconnected, the module automatically tests the battery each time it receives a new call. When  appears on the display or the display dims (even after you restore power), replace the battery.
- You must install a fresh battery within 5 seconds after you remove the old one. Otherwise, you might lose the information stored in the module.

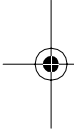

Follow these steps to install or replace the battery.

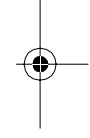

1. If the phone lines and AC adapter are already connected, unplug them from the module.

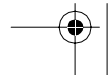
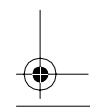
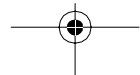
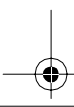

2. Use a coin or other flat object to turn the screw on the bottom of the module to **OPEN**, then slide off the battery compartment cover.

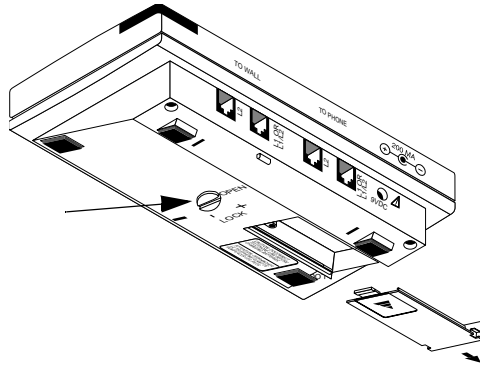

3. Remove and discard the old battery.

Important: Do not press any buttons after you remove the battery. Doing so can delete all caller information from the module.

Caution: Always remove an old or weak battery. Batteries can leak chemicals that can damage electronic circuits.

4. Before the display dims, slide the fresh battery into the compartment as indicated by the polarity symbols (+ and -) marked inside.

Caution: Do not force the battery into the compartment.

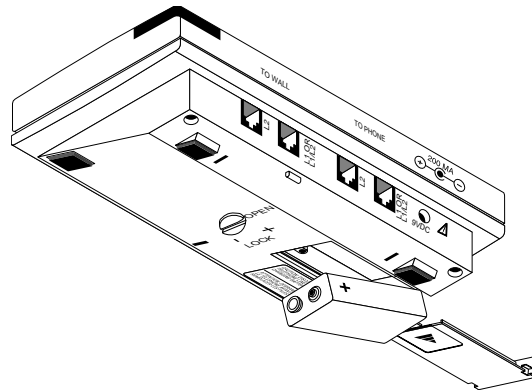

5. Replace the battery compartment cover and turn the screw on the bottom of the module to **LOCK** to secure it. Then reconnect the phone lines and the AC adapter, if necessary.

SETTING THE DISPLAY LANGUAGE

When you connect power to the module the first time, the module begins its start-up sequence. The message received indicator on the front of the module lights, and a test screen and the total memory capacity appear on the display. Then the module displays:

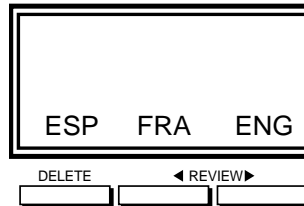

To select Spanish, press **DELETE**. To select French, press **◀ REVIEW**. To select English, press **REVIEW ▶**.

To change the language selection later, remove the battery and unplug the AC adapter. Wait until the display dims, then reinstall the battery and plug in the AC adapter. After the module performs the start-up sequence again, press the appropriate button to select the desired language.

Caution: Changing the language selection deletes all caller information from the module.

ADJUSTING THE DISPLAY CONTRAST

Follow these steps to adjust the display's contrast for the best visibility.

1. Press and hold down **DELETE**.
2. While holding down **DELETE**, within 6 seconds, repeatedly press **◀ REVIEW** to decrease the contrast or **REVIEW ▶** to increase it.

Caution: While reviewing call records, if you hold down **DELETE** for longer than 6 seconds without pressing a **REVIEW** button, the system deletes all caller information from its memory.

3. Release **DELETE**.

CONNECTING TO THE PHONES/PHONE LINES

The module connects to your phone(s) and the phone line(s) using four modular phone line connectors. You can connect your module between a two-line phone (or one or two one-line phones) and a two-line modular phone line jack (or two one-line jacks). To use all of the module's features, you must connect it to two separate phone lines. Each of these lines must have its own phone number. If you do not have two phone lines, contact your phone company to get a second line.

Notes:

- If you connect the module to only one phone line, the module displays Caller ID information only for that line.
- If your phone lines do not have modular jacks, you can update the wiring yourself. Or, you can have the telephone company update your telephone wiring for you.
 - RadioShack stores sell jacks and adapters to convert older wiring methods to modular wiring.
 - The telephone company charges to install the necessary jacks.
 - The USOC number of the jack to be installed is RJ11C (for a one-line phone line jack) or RJ14C (for a two-line phone line jack).

Connecting to a Two-Line Phone and a Two-Line Phone Line Jack

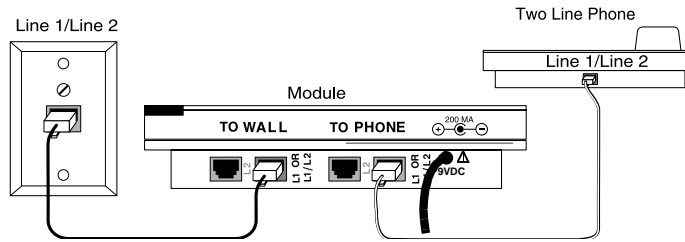

Connecting to a Two-Line Phone and Two One-Line Jacks

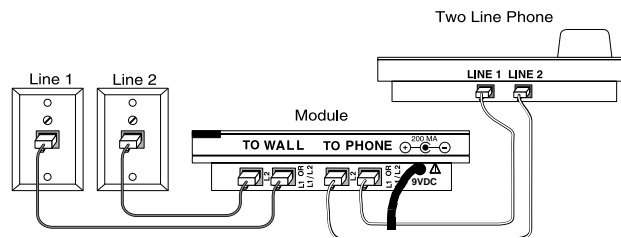

Connecting to a One-Line Phone and a Two-Line Phone Line Jack

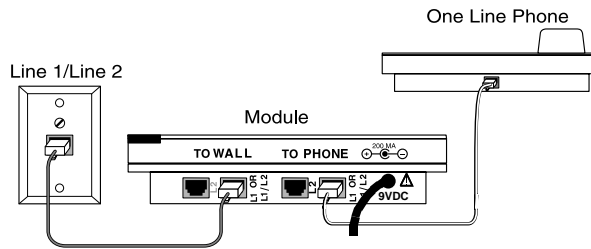

Connecting to Two One-Line Phones and a Two-Line Phone Line Jack

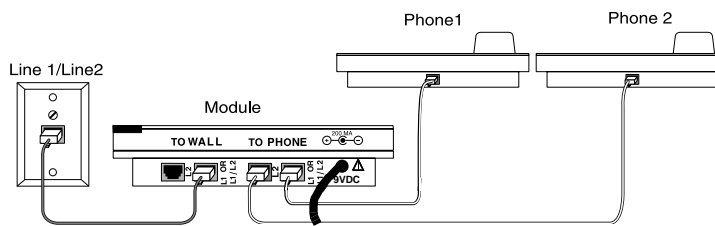

Connecting to Two One-Line Phones and Two One-Line Jacks

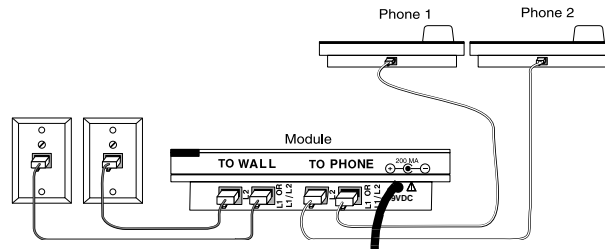

CONNECTING TO AN ANSWERING MACHINE

You can connect an answering machine to your module, phone, and phone line. After you connect the answering machine, set it to answer calls after at least two rings.

Connecting for Both Lines or Line 1 Only

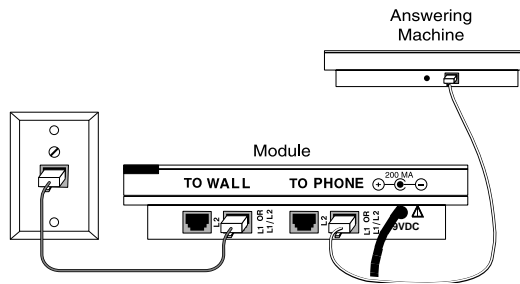

Connecting for Line 2 Only

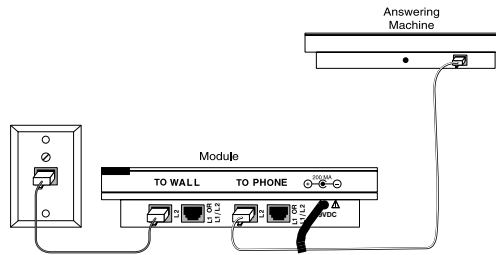

MOUNTING THE MODULE

You can place the module directly on a desk, shelf, or table. Or, you can mount the module on a wall. To mount the module on the wall, you need two screws (not supplied) with heads larger than the holes on the back of the supplied mounting bracket.

Follow these steps to mount the module on a wall.

1. Drill two holes into the wall $2\frac{17}{32}$ inches apart.

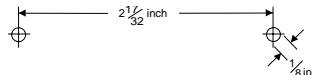

2. While holding the side of the mounting bracket against the wall as shown, thread a mounting screw through each round hole in the mounting bracket then tighten the mounting screws into the wall.

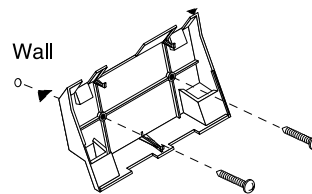

3. Route the phone line cords and AC adapter cord through the upper and lower slots on the mounting bracket.

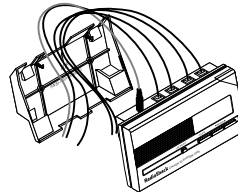

4. Align the slots on the back of the module with the hooks on the mounting bracket, then gently push the module down on the mounting bracket to secure it.

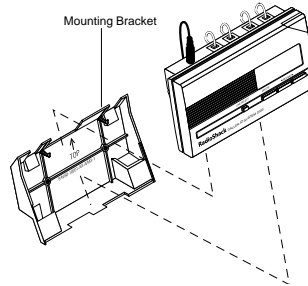

OPERATION

RECEIVING AND STORING CALLS

When you receive a call, the Caller ID information sent by the phone company, including the caller's telephone number (and name, if available) and the call's date and time, automatically appears on the display between the first and second rings. The module also displays the line on which the call was received.

As it receives calls, the module stores the information for later recall.

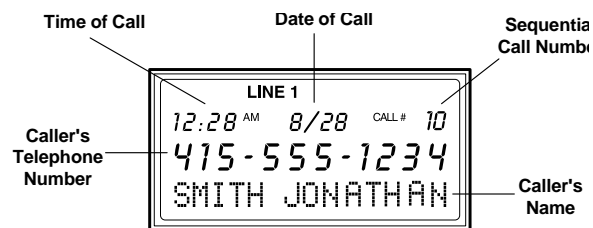

Notes:

- If you receive a call then receive another call within 5 seconds, the module does not store information about the second call.
- After the module's memory is full, the next call's information replaces the oldest stored records.

The module displays the current date and time (as sent by the telephone company with call information).

REVIEWING CALLS

- To select the line you want to review, press **LINE SELECT** until **LINE 1** or **LINE 2** appears on the display. Each time you press **LINE SELECT**, the module displays **LINE 1**, **LINE 2**, and both **LINE 1** and **LINE 2**, in order.

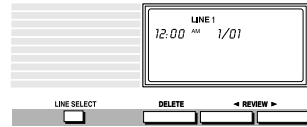

Repeatedly press **REVIEW >** to view more recent calls on the line(s) you selected. Repeatedly press **< REVIEW** to review previous calls.

- To select both lines and review all calls on both lines (in the order the calls were received), repeatedly press **LINE SELECT** until **LINE 1** and **LINE 2** appear on the display, then repeatedly press **REVIEW >** or **< REVIEW**.

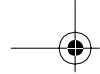

Notes:

- If there are no calls stored in the module, **-NO CALLS-** appears on the display when you press a **REVIEW** button.
- **-END OF LIST-** appears on the display when you reach the last stored call record while pressing the **REVIEW** buttons.
- The display automatically returns to the currently selected line and the current time and date display about 20 seconds after you last press any button. If you do not press a **REVIEW** button to review calls, the message received indicator still flashes to indicate the status of new calls.

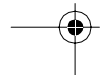
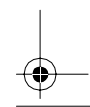
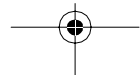
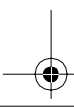
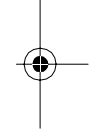
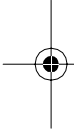

DISPLAYED CALL INFORMATION

The module might display any of the following information.

Indicator	Information
UNAVAILABLE	Appears instead of the phone number if the caller is calling from outside a Caller ID service area.
ANONYMOUS CALL	Appears instead of the phone number (for about 30 seconds) if the caller has chosen to block sending of their Caller ID information. The message received indicator on the front of the module flashes while the phone rings.
NO DATA SENT	Appears when call information is not sent by the phone company. This happens if you have not subscribed to Caller ID service or if you answer the call before the second ring.

Indicator	Information
LINE ERROR	Appears if there is an error in the Caller ID transmission. Note: Minor electrical disturbances can affect the caller ID information. Occasional errors are normal. If the module frequently displays LINE ERROR , contact your phone service provider or local RadioShack store for assistance.
MESSAGE WAITING	Appears if you subscribe to your phone company's voice mail feature and you have new voice mail. The message received indicator flashes until you retrieve the message from the phone company. Note: The voice mail indication is available only on Line 1 of your module.

Indicator	Information
NEW L1=(number of new calls) L2=(number of new calls)	Appears if the module received one or more calls on a line since the last time you reviewed call records. The message received indicator flashes rapidly. Press either REVIEW button to turn off the indicator. Note: If there are one or more new calls on both lines, you must review at least one new call on both lines before you can turn the message received indicator off.

DELETING CALLS

When the module's memory is full, it automatically deletes the oldest call information when a new call arrives. You can also manually delete one or more calls on a line, and delete all calls on one or both lines.

Deleting a Single Call

1. To select the line for the call you want to delete, press **LINE SELECT** until **LINE 1** or **LINE 2** appears on the display.



2. Repeatedly press **REVIEW >** or **< REVIEW** to select the call to delete, then quickly press **DELETE** twice.

Deleting All Calls

Follow these steps to delete all calls on one line.

1. Repeatedly press **LINE SELECT** until **LINE 1** or **LINE 2** appears on the display.
2. Press **REVIEW ►** or **◄ REVIEW** to select any stored call.
3. Quickly press and release **DELETE**, then hold down **DELETE**. After about 5 seconds, the module deletes all calls on the line you selected and displays **-NO CALLS-**.
4. Release **DELETE**.

Follow these steps to delete all calls on both lines.

1. Repeatedly press **LINE SELECT** until **LINE 1** and **LINE 2** appear on the display.
2. Press **REVIEW ►** or **◄ REVIEW** to select any stored call.
3. Quickly press and release **DELETE**, then hold down **DELETE**. After about 5 seconds, the module deletes all calls on both lines and displays **-NO CALLS-**.
4. Release **DELETE**.

CARE AND MAINTENANCE

Your RadioShack Caller ID System 2000 is an example of superior design and craftsmanship. The following suggestions will help you care for the module so you can enjoy it for years.



Keep the module dry. If it gets wet, wipe it dry immediately. Liquids can contain minerals that can corrode the electronic circuits.



Handle the module gently and carefully. Dropping it can damage circuit boards and cases and can cause the module to work improperly.



Use and store the module only in normal temperature environments. Temperature extremes can shorten the life of electronic devices, damage batteries, and distort or melt plastic parts.



Keep the module away from dust and dirt, which can cause premature wear of parts.



Wipe the module with a damp cloth occasionally to keep it looking new. Do not use harsh chemicals, cleaning solvents, or strong detergents to clean it.

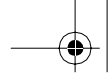

Modifying or tampering with your module's internal components can cause a malfunction and might invalidate the module's warranty. If your module is not operating as it should, take it to your local RadioShack store for assistance. If the trouble is harming the telephone lines, the telephone company might ask you to disconnect your module until you have resolved the problem.

LIGHTNING

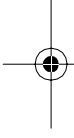

Your module has built-in protection circuits to reduce the risk of damage from surges in telephone line current. These protection circuits meet or exceed the FCC requirements. However, lightning striking the telephone lines can damage your module.

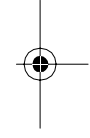

Lightning damage is not common. However, if you live in an area that has severe electrical storms, we suggest you unplug your module during storms to reduce the possibility of damage.

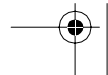
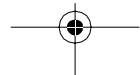
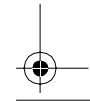
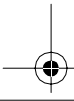

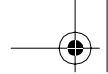

NOTES

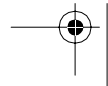
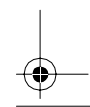
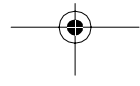
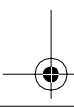
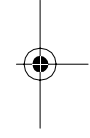
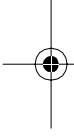

RadioShack Limited Warranty

This telephone product is warranted against manufacturing defects in material and workmanship for one (1) year from the date of purchase from RadioShack company owned stores and authorized RadioShack franchisees and dealers. Within this period **bring your RadioShack sales slip** as proof-of-purchase date to any RadioShack store.

This warranty does not cover damage or failure caused by or attributable to Acts of God, abuse, misuse, improper or abnormal usage, faulty installation, improper maintenance, lightning or other incidence of excess voltage, or any repairs other than those provided by a RadioShack Authorized Service Facility, or transportation costs. **RadioShack is not responsible or liable for indirect, special, or consequential damages arising out of or in connection with the use or performance of the product or other damages with respect to loss of property, loss of revenue or profit, or costs of removal, installation or reinstallation.**

EXCEPT AS PROVIDED HEREIN, RadioShack MAKES NO EXPRESS WARRANTIES AND ANY IMPLIED WARRANTIES ARE LIMITED IN DURATION TO THE DURATION OF THE WRITTEN LIMITED WARRANTIES CONTAINED HEREIN. Some states do not allow the limitation or exclusion of incidental or consequential damages and some states do not allow limitation or exclusion of implied warranties; therefore, the aforesaid limitation(s) or exclusion(s) may not apply to the purchaser. There will be charges rendered for repairs to the product made after the expiration of the aforesaid one (1) year warranty period.

This warranty gives you specific legal rights and you may also have other rights which vary from state to state.

We Service What We Sell

10/95

RadioShack
A Division of Tandy Corporation
Fort Worth, Texas 76102

7A6

Printed in Thailand